

Activated carbon adsorber CTAP30

Rev 01_1224

Technical data sheet

Page 1 of 2

Nominal capacity (based on ambient conditions 14.5 psi, 68°F)	Unit	Design data
Volume flow inlet	scfm	30
Volume flow outlet	scfm	29
Compressed air inlet temperature	°F	95
Working pressure	psig	102
Residual oil content	mg/m ³	< 0,003

General data	Unit	Design data
Maximum operating pressure	psig	232
Minimum operating pressure	psig	0
Maximum inlet temperature	°F	122°F (77° eff.)
Ambient temperature minimum	°F	35.6

Norms and key figures	Unit	Design data
North America		ASME B31.3 - 2020
Canada		CSA B-51
Testing pressure	psig	348

Scope of supply	Unit	Design data
Ready-to-operate adsorption dryer	Type	CTAP30
Final filter	Type	APF35-38DMF
Filling	Type	Activated carbon dedusted
Oil indicator A-4000-120		no

Options	Unit	Design data
Pre filter	Type	APF35-38SMA

Activated carbon adsorber CTAP30

Rev 01_1224

Technical data sheet

Dimensions and weights	Unit	Design data
A	inch	36.76
B	inch	34.16
C	inch	11.94
D	inch	8.27
Nominal size inside the adsorber	inch	3/8"
Connection inlet	inch	1/2" NPT
Connection outlet	inch	3/8" NPT
Total weight	lbs	37.4
Volume (chamber)	gallon	1.57

Dimensional drawings

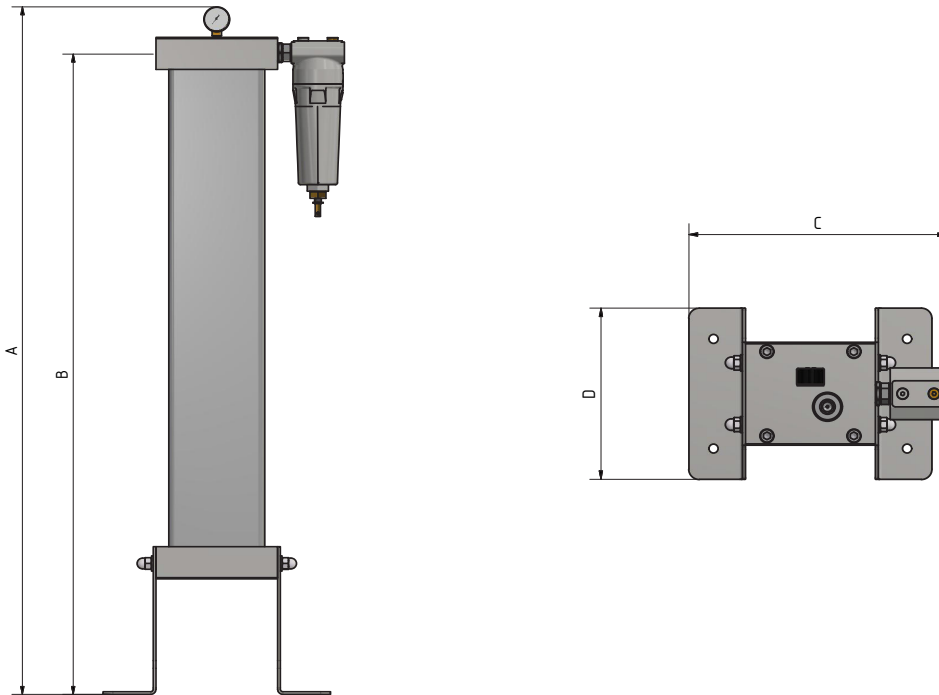

Correction factors										
Inlet temperature										
°F	< 77	77	86	95	100	104	113	118	122	
F(t)	1.2	1.1	1.09	1	0.84	0.78	0.72	0.65	0.58	

Correction factors working pressure																									
psig	58	65	72.5	80	87	94	102	109	116	123	130	138	145	152	160	167	174	181	189	196	203	210	218	225	232
F(p)	0.6	0.7	0.74	0.82	0.89	0.97	1	1.08	1.11	1.16	1.22	1.29	1.36	1.42	1.5	1.57	1.63	1.69	1.75	1.83	1.9	1.96	2.03	2.1	2.14

Please multiply the capacity with the correction factors in the above table