

Adsorption dryer DDAP110

Rev 01_0125

Technical data sheet

Page 1 of 2

Nominal capacity (based on ambient conditions 14.5 psi, 68 °F)	Unit	Design data
Volume flow inlet	scfm	106
Volume flow outlet	scfm	91
Average purge air	scfm	14.8
Compressed air inlet temperature	°F	95
Working pressure	psig	102
Pressure dew point	°F	-40
Residual oil content	mg/m ³	x

General data	Unit	Design data
Maximum operating pressure	psig	232
Minimum operating pressure	psig	58
Maximum inlet temperature	°F	122
Ambient temperature minimum	°F	35.6

Norms and key figures	Unit	Design data
North America		ASME B31.3 - 2020
Canada		CSA B-51
Testing pressure	psig	348
Sound insulation level		ISO 85

Scope of supply	Unit	Design data
Ready-to-operate desiccant dryer	Type	DDAP110
Control unit	Type	ECOMATIC22
Pre filter	Type	APF130-1SMA
Final filter	Type	APF130-1DMF
Desiccant filling	Type	Alumina

Options	Unit
Controls	Dew point device ETC4.0
	Dew point device ETP4.0 (incl. inlet air control)
Minimum pressure devices	AV G 1/2", AV G 3/4"

Cycles	Unit	Design data
Total	min	10
Adsorption	min	4.5
Regeneration	min	4.5
Pressure build-up time	min	1

Adsorption dryer DDAP110

Rev 02_0425

Technical data sheet

Dimensions and weights	Unit	Design data
A	inch	45.11
B	inch	27.03
C	inch	21.39
D	inch	33.17
Nominal size inside the adsorber	inch	1" NPT
Connection input	Inch	1" NPT
Output connection	Inch	1" NPT
Total weight	lbs	327.8
Vessel volume	gallon	3.1

Electrical data	Unit	Design data
Installed capacity	HP	0.043
Connector	V	115
Control voltage	V	115
Rate	Hz	50 / 60
Protection class housing	IP	54

Dimensional drawings

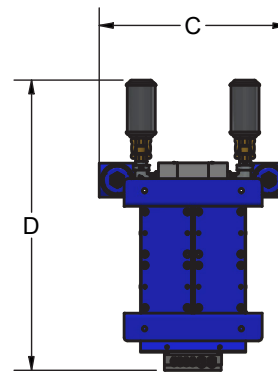
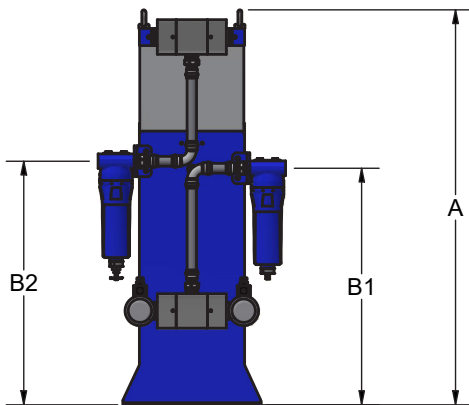

Correction factors	
Inlet temperature	
°F	< 77 77 86 95 100 104 113 118 122
F(t)	1.2 1.1 1.09 1 0.84 0.78 0.72 0.65 0.58

Correction factors working pressure	
psig	58 65 72.5 80 87 94 102 109 116 123 130 138 145 152 160 167 174 181 189 196 203 210 218 225 232
F(p)	0.6 0.7 0.74 0.82 0.89 0.97 1 1.08 1.11 1.16 1.22 1.29 1.36 1.42 1.5 1.57 1.63 1.69 1.75 1.83 1.9 1.96 2.03 2.1 2.14

Please multiply the capacity with the correction factors in the above table