

Adsorption dryer DDAP6

Rev 01_0125

Technical data sheet

Page 1 of 2

Nominal capacity (based on ambient conditions 14.5 psi, 68 °F)		
	Unit	Design data
Volume flow inlet	scfm	6
Volume flow outlet	scfm	5
Average purge air	scfm	0,8
Compressed air inlet temperature	°F	95
Working pressure	psig	102
Pressure dew point	°F	-40
Residual oil content	mg/m ³	x

General data		
	Unit	Design data
Maximum operating pressure	psig	232
Minimum operating pressure	psig	58
Maximum inlet temperature	°F	122
Ambient temperature minimum	°F	35,6

Norms and key figures		
	Unit	Design data
North America		ASME B31.3 - 2020
Canada		CSA B-51
Testing pressure	psig	348
Sound insulation level		ISO 85

Scope of supply		
	Unit	Design data
Ready-to-operate desiccant dryer	Type	DDAP6
Control unit	Type	ECOMATIC22
Pre filter	Type	APF35-38SMA
Final filter	Type	APF35-38DMF
Desiccant filling	Type	Alumina

Options		
	Unit	
Controls		Dew point device ETC4.0
		Dew point device ETP4.0 (incl. inlet air control)
Minimum pressure devices		AV G 1/2", AV G 3/4"

Cycles		
	Unit	Design data
Total	min	10
Adsorption	min	4,5
Regeneration	min	4,5
Pressure build-up time	min	1

Adsorption dryer DDAP6

Rev 01_0125

Technical data sheet

Dimensions and weights	Unit	Design data
A	inch	28,49
B	inch	25,02
C	inch	14,7
D	inch	12,06
Nominal size inside the adsorber	inch	3/8" NPT
Connection input	inch	3/8" NPT
Output connection	inch	3/8" NPT
Total weight	lbs	39,6
Vessel volume	gallon	0,49

Electrical data	Unit	Design data
Installed capacity	HP	0,043
Connector	V	115
Control voltage	V	115
Rate	Hz	50 / 60
Protection class housing	IP	54

Dimensional drawings

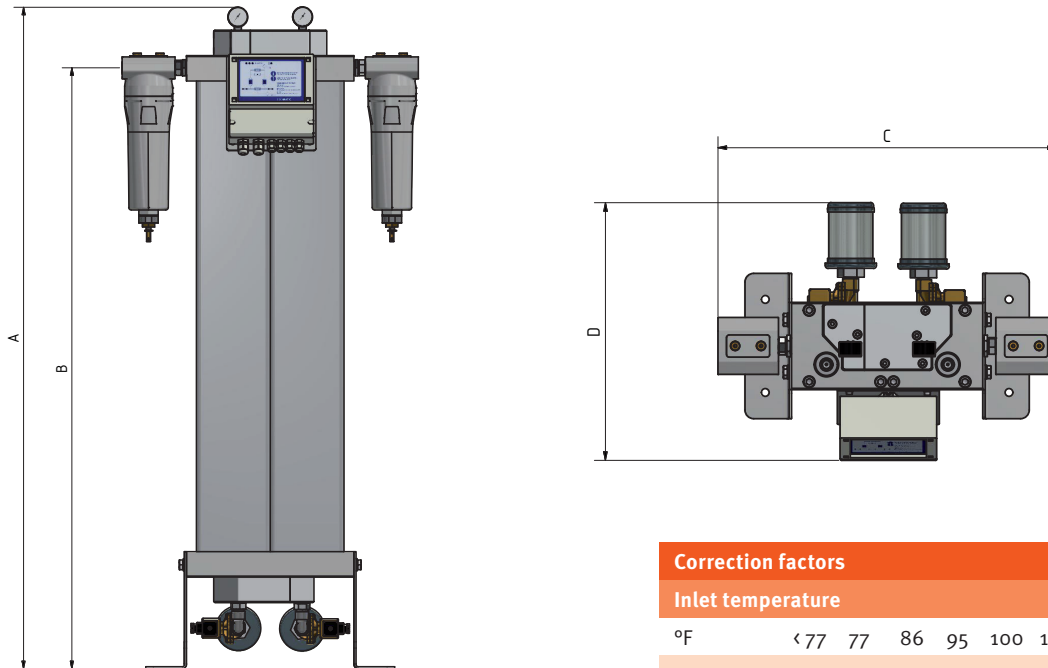

Correction factors	
Inlet temperature	
°F	< 77 77 86 95 100 104 113 118 122
F(t)	1,2 1,1 1,09 1 0,84 0,78 0,72 0,65 0,58

Correction factors working pressure	
psig	58 65 72,5 80 87 94 102 109 116 123 130 138 145 152 160 167 174 181 189 196 203 210 218 225 232
F(p)	0,6 0,7 0,74 0,82 0,89 0,97 1 1,08 1,11 1,16 1,22 1,29 1,36 1,42 1,5 1,57 1,63 1,69 1,75 1,83 1,9 1,96 2,03 2,1 2,14

Please multiply the capacity with the correction factors in the above table